

Tous droits strictement réservés. Reproduction ou communication a des tiers interdite sous quelque forme que ce soit sans autorisation écrite du propriétaire. Propriété de c FCI. Droits de reproduction FCI.



All rights strictly reserved. Reproduction or issue to third parties in any form whatever is not permitted without written authority from the proprietor. Property of FCI. Copyright FCI.

PRODUCT NUMBER

51415-00X\_\_  
SEE NOTE: 3

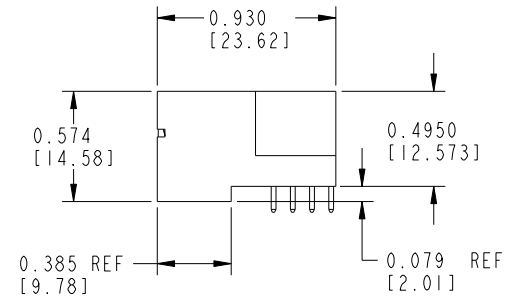
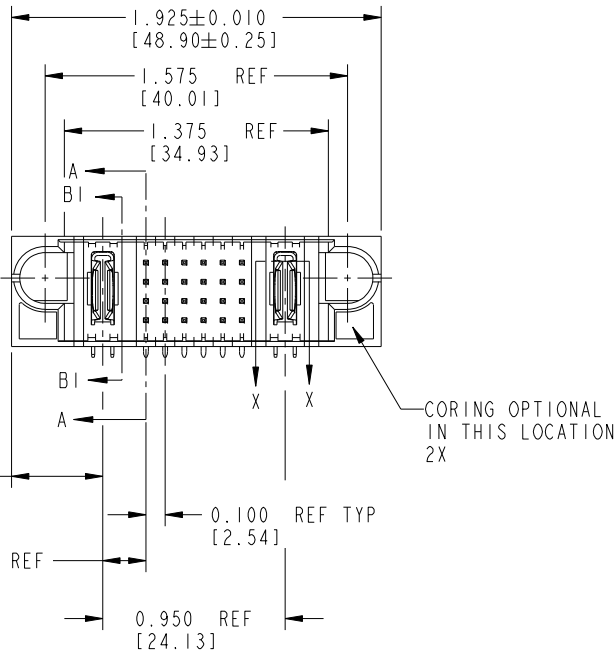
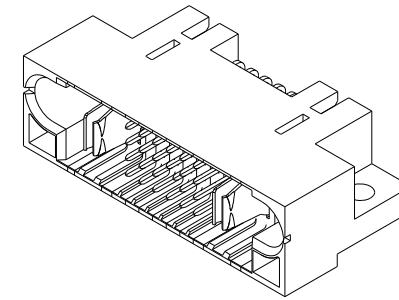
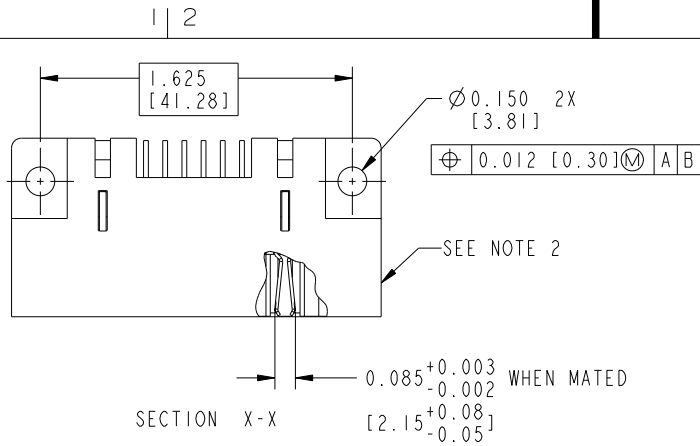

mat'l code				SEE NOTES		tolerances unless otherwise specified		CUSTOMER		FCI	
ltr	ecn no.	dr	date	linear	.XX±.01/.X±.3	projection		COPY		www.fciconnect.com	
K	DG05-0064	SW	3/30/05		.XXX±.005/.X±.13	INCH/MM		title		IP + 24S + IP	
L	DG05-0435	SW	11/03/05	angles	.XXX±.0020/.XXX±.051	scale		product family		PWRBLADE	
M	DG08-0237	W D	09/01/08	dr	0°±2°	1:1		size		213	
N	DG08-0272	W D	09/25/08	enrg	C. BAROT 01-12-99			dwg no		51415	
				chr	J. BROWN 01-12-99			sheet		1 of 5	
				appd	J. BROWN 01-12-99			code			
sheet index	revision sheet	N 1	N 2	N 3	N 4	N 5					

Pro/E

PDM: Rev: N

STATUS: Released

Printed: Oct 17, 2008

Tous droits strictement réservés. Reproduction ou communication a des tiers interdite sous quelque forme que ce soit sans autorisation écrite du propriétaire. Propriété de c FCI. Droits de reproduction FCI.

All rights strictly reserved. Reproduction or issue to third parties in any form whatever is not permitted without written authority from the proprietor. Property of FCI. Copyright FCI.



PRODUCT NUMBER  
51415-00X\_\_

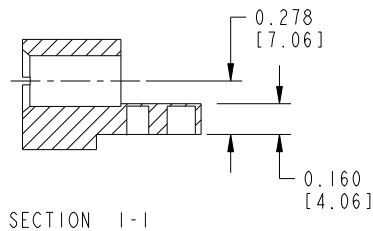
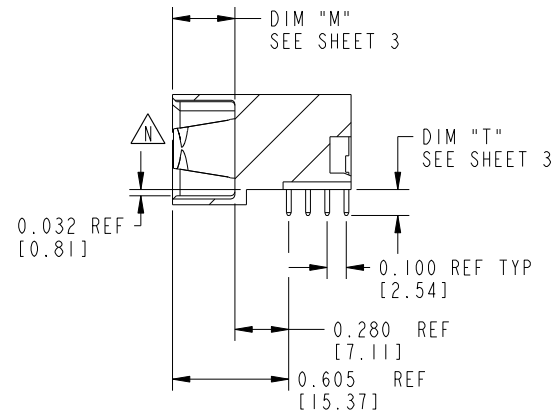
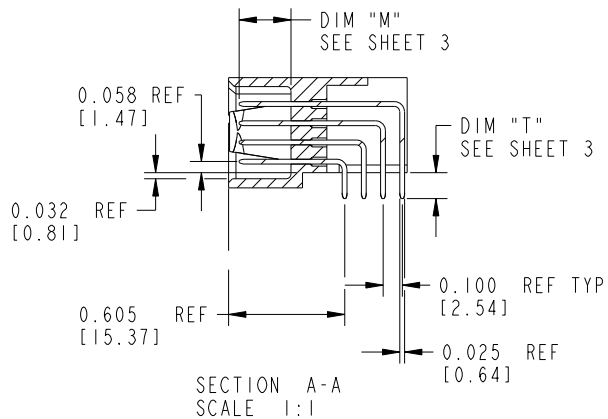

mat'l code		SEE NOTES		tolerances unless otherwise specified		CUSTOMER		 www.fciconnect.com	
lfr	ecn no.	dr	date	linear	.XX±.01/0.X±0.3	COPY		title	
N					.XXX±.005/0.XX±0.13	projection	IP + 24S + IP		
					.XXX±.0005/0.XXX±.051		Right Angle Solder Header		
				angles	0°±2°	INCH/MM		product family	
				dr	C. BAROT 01-12-99	scale		PWRBLADE	
				enrg	J. BROWN 01-12-99	1:1		code	
				chr	J. BROWN 01-12-99	A		size	
				appd	J. BROWN 01-12-99	51415		sheet	
sheet index		revision sheet						2 of 5	

Pro/E

PDM: Rev: N

STATUS: Released

Printed: Oct 17, 2008

Tous droits strictement réservés. Reproduction ou communication a des tiers interdite sous quelque forme que ce soit sans autorisation écrite du propriétaire. Propriété de c FCI. Droits de reproduction FCI.



All rights strictly reserved. Reproduction or issue to third parties in any form whatever is not permitted without written authority from the proprietor. Property of FCI. Copyright FCI.

PRODUCT NUMBER  
51415-00X\_\_

ITEM NO.	QTY	DIM "M" MATING LENGTH ±.010		DIM "T" TAIL LENGTH ±.020		CONTACT TYPE
PA	2	N/A	[N/A]	0.135	[3.43]	POWER
F	1	0.220	[5.59]	0.135	[3.43]	SIGNAL
R	6	0.270	[6.86]	0.135	[3.43]	SIGNAL
S	5	0.270	[6.86]	0.135	[3.43]	SIGNAL
T	6	0.270	[6.86]	0.135	[3.43]	SIGNAL
U	6	0.270	[6.86]	0.135	[3.43]	SIGNAL

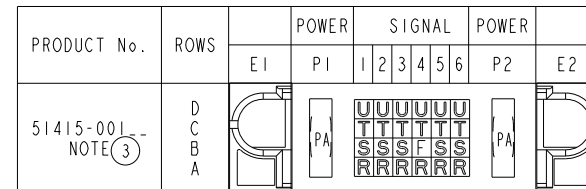

ITEM NO.	QTY	DIM "M" MATING LENGTH ±.010		DIM "T" TAIL LENGTH ±.020		CONTACT TYPE
PS	2	N/A	[N/A]	0.135	[3.43]	POWER
E	6	0.220	[5.59]	0.135	[3.43]	SIGNAL
F	5	0.220	[5.59]	0.135	[3.43]	SIGNAL
G	6	0.220	[5.59]	0.135	[3.43]	SIGNAL
H	6	0.220	[5.59]	0.135	[3.43]	SIGNAL
S	1	0.270	[6.86]	0.135	[3.43]	SIGNAL

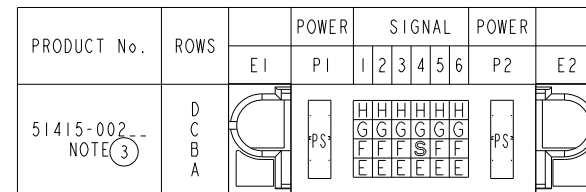

ITEM NO.	QTY	DIM "M" MATING LENGTH ±.010		DIM "T" TAIL LENGTH ±.020		CONTACT TYPE
PS	2	N/A	[N/A]	0.135	[3.43]	POWER
F	1	0.220	[5.59]	0.135	[3.43]	SIGNAL
R	6	0.270	[6.86]	0.135	[3.43]	SIGNAL
S	5	0.270	[6.86]	0.135	[3.43]	SIGNAL
T	6	0.270	[6.86]	0.135	[3.43]	SIGNAL
U	6	0.270	[6.86]	0.135	[3.43]	SIGNAL

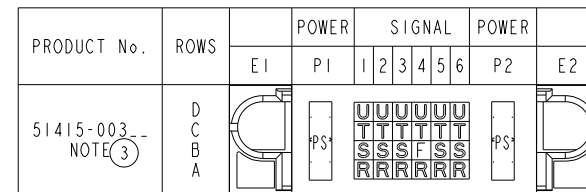

mat'l code				SEE NOTES		tolerances unless otherwise specified		CUSTOMER		FCI	
lir	ecn no.	dr	date	linear	.XX±.01/0.X±0.3	projection	COPY		www.fciconnect.com		
N				angles	.XXX±.005/0.XX±0.13		title		IP + 24S + IP		
				dr	.XXX±.0005/0.XXX±.051		product family		Right Angle Solder Header		
				enrg	0°±2°	INCH/MM	size		PWRBLADE		
				chr	C. BAROT 01-12-99	scale	51415		code 213		
				appd	J. BROWN 01-12-99	1:1	A		sheet 3 of 5		
sheet index		revision sheet									

Tous droits strictement réservés. Reproduction ou communication a des tiers interdite sous quelque forme que ce soit sans autorisation écrite du propriétaire. Propriété de c FCI. Droits de reproduction FCI.



All rights strictly reserved. Reproduction or issue to third parties in any form whatever is not permitted without written authority from the proprietor. Property of FCI. Copyright FCI.

PRODUCT NUMBER  
51415-00X\_\_

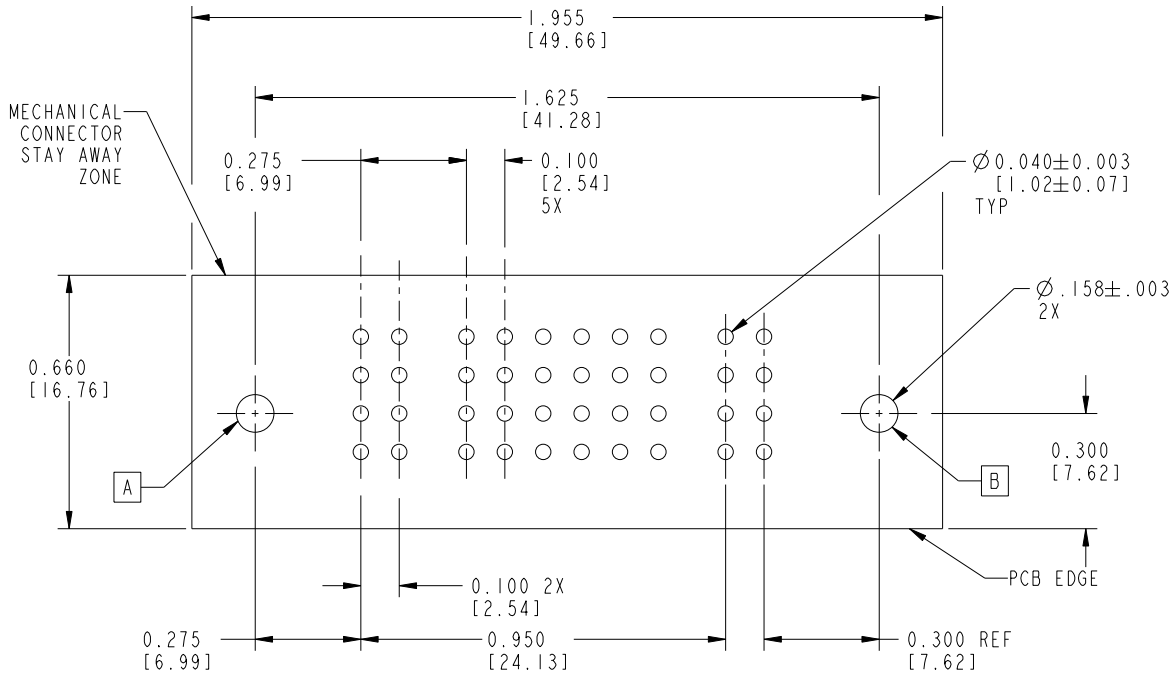

SCALE 2:1

RECOMMENDED PCB LAYOUT

mat'l code		SEE NOTES		tolerances unless otherwise specified		CUSTOMER		FCI	
lir	ecn no.	dr	date	linear	.XX±.01/0.X±0.3	COPY		www.fciconnect.com	
N				angles	.XXX±.005/0.XX±0.13	projection		title IP + 24S + IP	
				dr	.XXX±.0005/0.XXX±.051	INCH/MM		Right Angle Solder Header	
				enr	0°±2°	scale		product family PWRBLADE	
				chr		1:1		code 213	
				appd		A		size 51415	
sheet index		revision sheet						sheet 4 of 5	

code code 22526

Pro/E

PDM: Rev: N

STATUS: Released

Printed: Oct 17, 2008

PRODUCT NUMBER
51415-00X__

NOTES:

1. DIMENSIONS AND TOLERANCES ARE IN ACCORDANCE WITH ASME Y14.5M, 1994 UNLESS OTHERWISE SPECIFIED.

CONNECTOR NOTES:

2. HOUSING MATERIAL: UL 94 V-0 GLASS FILLED HIGH-TEMP THERMOPLASTIC  
POWER CONTACT MATERIAL: COPPER ALLOY  
SIGNAL PIN MATERIAL: COPPER ALLOY

 3. SEE ITEM 1 & 2 IN PRINT 10064183 FOR PLATING SPEC OF 51415-00X AND 51415-00XLF RESPECTIVELY.

4. MANUFACTURER'S NAME, P/N, AND DATE CODE TO APPEAR ON THIS SURFACE.

5. PRODUCT SPECIFICATION GS-12-149.  
APPLICATION SPECIFICATION BUS-20-067.

PCB NOTES:

6. ALL HOLE DIAMETERS ARE FINISHED HOLE SIZE.

7. MOUNTING HOLES, WHERE APPLICABLE, ARE UNPLATED.

8.  $\varnothing .0453 \pm 0.0010$  [ $1.151 \pm 0.025$ ] DRILLED HOLES PLATED WITH  
.0003 [0.008] MIN SnPb OVER .001 [0.03]  
TO .003 [0.08] Cu PLATING TO ACHIEVE  
 $\varnothing .040 \pm .003$  [ $1.02 \pm .07$ ] HOLE.

9. "DIM XXX" TO BE DETERMINED BY THE CUSTOMER.

10. CONNECTOR KEEP-OUT ZONE.

11. A  SYMBOL WILL BE NEXT TO ANY DIMENSION, VIEW, OR NOTE WHICH HAS BEEN MODIFIED WITH THE CURRENT DRAWING REVISION.

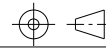
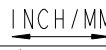
mat'l code		SEE NOTES		tolerances unless otherwise specified		CUSTOMER					
ltr	ecn no.	dr	date	linear	.XX±.01/0.X±0.3		projection	www.fciconnect.com			
N					.XXX±.005/0.XX±0.13				title IP + 24S + 1P		
					.XXX±.0005/0.XXX±.051				Right Angle Solder Header		
				angles	0°±2°			product family PWRBLADE			
				dr	C. BAROT	01-12-99		size	dwg no	code	
				enrg	J. BROWN	01-12-99	scale	A	51415	213	
				chr	J. BROWN	01-12-99				sheet	5 of 5
				appd	J. BROWN	01-12-99					
sheet index	revision sheet										

Tous droits strictement réservés. Reproduction ou communication a des tiers interdite sous quelque forme que ce soit sans autorisation écrite du propriétaire. Propriété de c FCI. Droits de reproduction FCI.



All rights strictly reserved. Reproduction or issue to third parties in any form whatever is not permitted without written authority from the proprietor. Property of FCI. Copyright FCI.